



User Manual

5G PRO INVERTER













KSY:- 15KW- 25KW - 3Ph

Three-Phase Grid-tied Solar Inverter

CATALOGUE

1.	SYMBOLS ON THE LABEL	3
2.	SAFETY AND WARNINGS	3
3.	UNPACKING	4
3.1	Scope of Delivery	4
3.2	Product Overview	5
4.	INSTALLING	6
4.1	Installation Requirement	6
4.2	Mounting Location	7
4.3	Mounting	8
4.4	Installing the PE cable	8
5.	COMMISSIONING	09
5.1	Safety Instructions	10
5.2	AC Wire Assembly and Connection	12
5.3	DC Wire Assembly and Connection	13
5.4	Residual Current Protection	13
6.	COMMUNICATION	12
6.1	System monitoring via Datalogger - RS485/Wi-Fi /GPRS (Optional)	12
7.	START UP AND OPERATION	13
7.1	Safety Check Before Start Up	13
7.2	Inverter LED Indicators	14
8.	DISCONNECTING FROM VOLTAGE RESOURCES	15
10.	TROUBLE SHOOTING	16
11.	SYSTEM MAINTENANCE	18
12.	RESTARTS	19

1. SYMBOLS ON THE LABEL

	DANGER, WARNING AND CAUTION		RECYCLABLE AND REUSABLE
	HIGH VOLTAGE AVOID CONTACT		AVOID DAMP AND MOISTURE
	HIGH TEMPERATURE AVOID CONTACT		SHIPMENT STACK LIMIT: 7
	CE MARKS		DO NOT DISPOSE WITH HOUSEHOLD WASTE
	PROCEED OPERATIONS AFTER 5 MINUTES DISCHARGE		BREAKABLE ITEM
	PLACE UPWARDS		USER MANUAL IN PACK

2. SAFETY AND WARNINGS

1. All persons who are responsible for mounting, installation, commissioning, maintenance, tests, and service of KSOLARE inverter products must be suitably trained and qualified for corresponding operations. They MUST be experienced and have knowledge of operation safety and professional methods. All installation personnel must have knowledge of all applicable safety information, standards, directives, and regulations.
2. The product must ONLY be connected and operated with PV arrays of protection class II, in accordance with IEC 61730, application class A. The PV modules must also









be compatible with this product. Power resources other than compatible PV arrays MUST not be connected and operate with the product.

3. When designing or constructing a PV system, all components MUST remain in their permitted operating ranges, and their installation requirements MUST always be fulfilled.
4. Under exposure to sunlight, the PV array may generate dangerous output in DC voltage. Contacts with the DC wires, conductors and live components in the inverter may result in lethal shocks.
5. High voltages in inverter could cause lethal electrical shocks. Before proceeding any work, including maintenance and/or service, on the inverter, fully disconnect it from all DC input, AC grid and other voltage sources. There MUST be a 5-minute waiting time after the full disconnection.
6. The DC input voltage of the PV array MUST never exceed the maximum input voltage of the inverter.
7. DO NOT touch parts of the inverter during operation as heat will be induced and these parts will exceed 60^o.

3. UNPACKING

3.1 Scope of Delivery

Please inspect and check for completeness in the scope of delivery. Confirm with purchase order.

							
INVERTER	MOUNTING BRACKET	MOUNTING ACCESSORIES	DC PLUGS (sealed)	AC CONNECTOR	COM DATALOGGER (OPTIONAL)	METER / DRED CONNECTOR OPTIONAL	DOCUMENTS
1	1	1	24	1	1		1

3.2 Product Overview

The total size of KSY -15KW/18KW/20KW/25KW is 425(width) × 351(height) × 200(depth) mm. It has 4 pairs of PV input terminals and 2 communication ports. It also has a LED & LCD (or just LED, determined by user) for getting information and setting parameters at field.

The detail description is shown below:

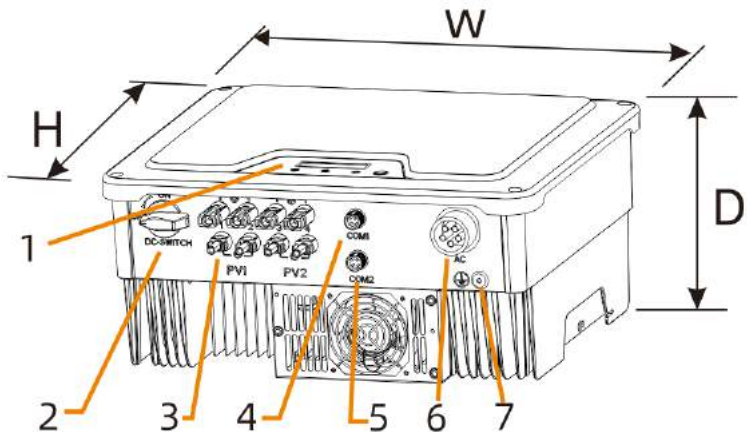

Mark Num .	Component	Description
1	LED&LCD or LED	Display and setting device at field
2	DC Switch	For switch on/off the inverter
3	PV Terminal (s)	Connected with PV Panel
4	COM1: Wi- Fi/GPRS /RS485	Alternative distant communication method
5	COM2: METER /DRED	For smart - meter or DRED
6	Secondary PE Terminal	For Grounding Protection
7	AC Terminal	Connected with AC Grid

4. INSTALLING

4.1 Installation Requirement

1. Please install the inverter(s) in places that can avoid inadvertent contact.
2. Installation method, location and surface must be fitting for the inverter's weight and dimensions.
3. Please install the inverter in an accessible location for operation, future maintenance and service.
4. The inverter performance peaks at ambient temperature lower than 45^o.
5. When installing in residential or domestic environment, it is recommended to install and mount the inverter on a solid, concrete wall surface. Mounting the inverter on composite or plaster boards or walls with similar materials would induce noise during its operation and is therefore not recommended.
6. DO NOT cover the inverter NOR place any objects on top of the inverter.
7. To ensure sufficient room for heat dissipation and maintenance, the clearing space between inverter(s) and other surroundings is indicated below for reference:

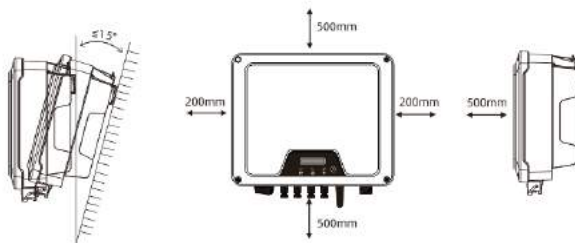

8. Avoid direct exposure to sun light and rain and snow layup.

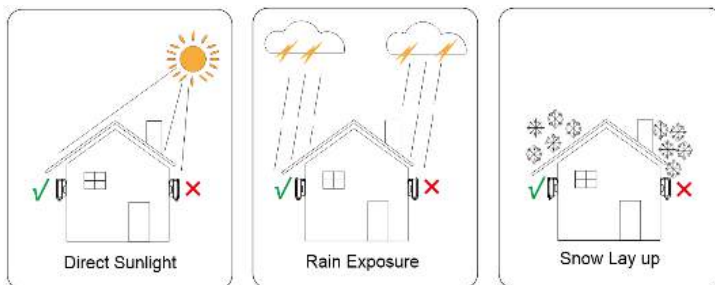

4.2 Mounting Location

1. DO NOT mount the inverter near any inflammable materials .
2. DO NOT mount the inverter near any explosive materials .

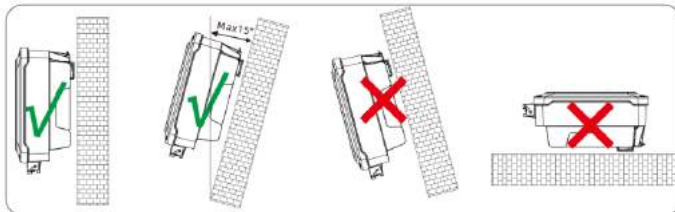

3. DO NOT mount the inverter on tilting surface over 15° backwards . Please mount the inverter on a vertical wall surface.
4. DO NOT mount the inverter on any surfaces tilting forward or to either sides.
5. DO NOT mount the i nverter on a horizontal surface.
6. For easy installation and operation, please m ount the inverter on a height that the display could match eye level.
7. The bottom side where a ll commissioning terminals are equipped MUST always point downwards.

4.3 Mounting

1. Use the mounting bracket as a template and drill holes of 10mm diameter and 70mm depth.
2. Fix the mounting bracket with the screws and expansion bolts packed in mounting accessories.
3. Hold up the inverter and tilt it slightly forward. Hang up the inverter and attach it to the mounting bracket. Check both sides of the heat sink to ensure its stably attached.
4. Use M5 screws (T25 screwdriver, torque 2.5 Nm) to attach the heat sink fins to the mounting bracket.
5. It is recommended to attach the anti-theft lock to the inverter. Lock diameter ϕ 4-5.5mm recommended.

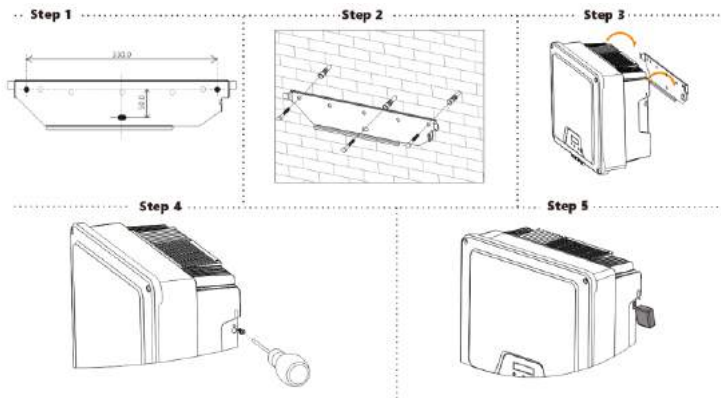

4.4 Installing the PE cable

1. Insert the grounding conductor into the suitable terminal lug and crimp the contact.
2. Align the terminal lug with the grounding conductor and the ground washer on the screw. The teeth of the ground washer must be facing the housing.
3. Tighten it firmly into the housing (screwdriver type: T25, torque: 2.5Nm).

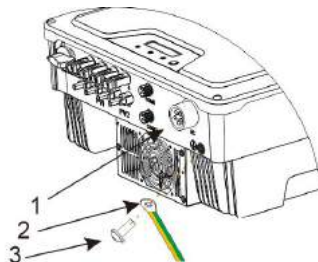

Information on grounding components:

Object	Description
1	Housing
2	M5 terminal lug with protective conductor
3	M6×12 pan head screw

PE Conductor cross - section: 16 mm²

5. COMMISSIONING

5.1 Safety Instructions

1. Measure the frequency and voltage of grid connection and make sure they follow the inverter's grid connection specifications.
2. An external circuit - breaker on the AC side (or a fuse) at 1.25*AC rated current is strongly recommended.
3. Reliability of all earth connections must be tested and valid .
4. Before commission ing, disconnect the inverter and the circuit - breaker or fuse, and prevent accidental reconnection.

5.2 AC Wire Assembly and Connection

5.2.1 AC Commissioning

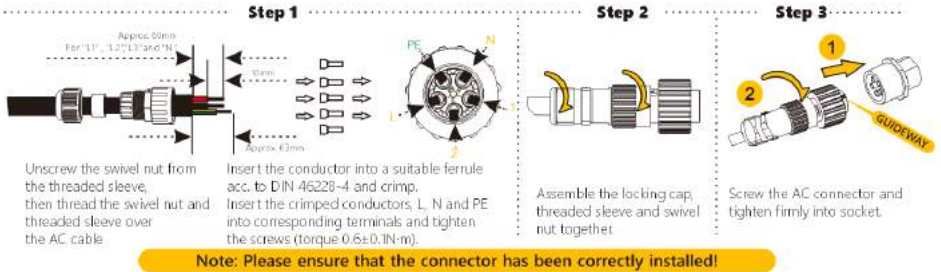

5.2.2 AC Switch Types

Please install an individual 2 - stage miniature circuit breaker according to the following specifications.

Model	Maximum output current (A)	AC Breaker Rated current (A)
KSY - 15KW	24	32
KSY - 18KW	27.6	32
KSY - 20KW	31.9	40
KSY - 25KW	36.3	50

5.3 DC Wire Assembly and Connection

1. PV modules of the connected strings must be of: the same time, identical alignment and tilting angle.
2. Before commissioning and connecting the PV arrays, the DC switch MUST be open.
3. Parallel strings must have the same number of modules.
4. It is mandatory to use the DC connectors within package for the connection of PV arrays.
5. The polarity of the PV arrays MUST be compatible to the DC connectors of the inverter.
6. The DC input voltage AND DC input current of the PV array MUST never exceed the maximum input allowance of the inverter.

DC Commissioning :

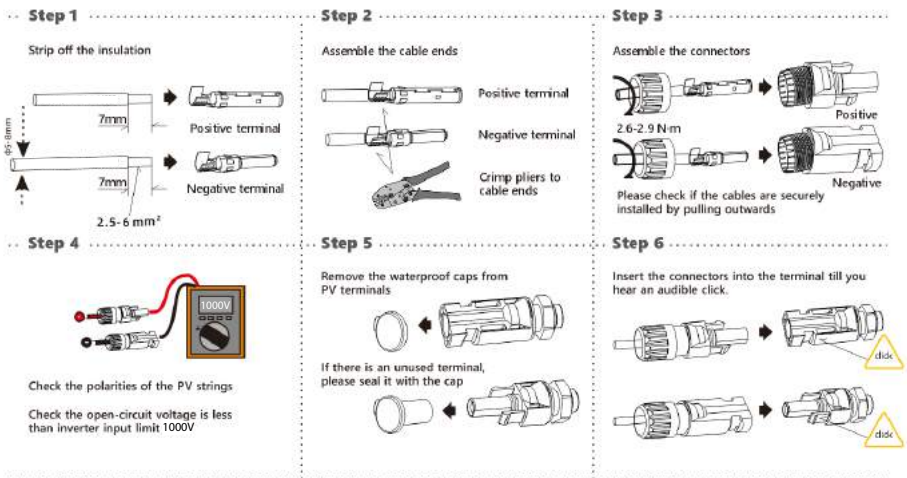

5.4 Residual Current Protection

This product is equipped with residual current protection device internally, in accordance with IEC 60364 - 7- 714. An external residual current protection device is not needed.

If the local regulation demands otherwise, it is recommended to install a 30mA Type B residual current protection device.

6. COMMUNICATION

6.1 System monitoring via Datalogger - RS485/ Wi- Fi /GPRS (Optional)

6.1.1 Wi- Fi /GPRS Datalogger Installation

1. Unpack the Datalogger from package.
2. Unscrew the cap in COM1 port and plug the Datalogger in and tighten.
3. For user guidance and configuration of Datalogger, please refer to the corresponding KSOLARE Wi- Fi Stick Guide manual, which is available in printed form inside Documents pack, or an online manual on KSOLARE website at www.ksolare.com

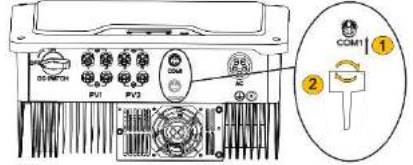

6.1.2 RS485/Smart Meter/DRED Connection

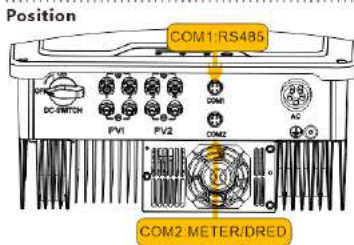

Step 1

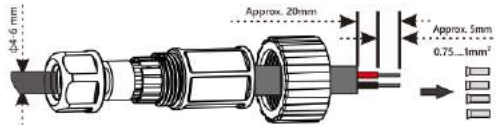

Insert the wires into suitable ferrules (DIN 46228) and crimp.

Step 2

Insert the crimped conductors accordingly into their corresponding terminals and tighten the screws use the screwdriver in the attached bag.

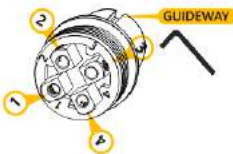

▶ RS485 FOR COM1

Power + ▶ PIN 1
Power - ▶ PIN2
RS485 A ▶ PIN3
RS485 B ▶ PIN4

▶ METER OR DRED FOR COM2

RS485 B ▶ PIN1
RS485 A ▶ PIN2
COM LOAD / 0 ▶ PIN3
REF GEN / 0 ▶ PIN4

Step 3

Assemble the locking cap, threaded sleeve and swivel nut together.

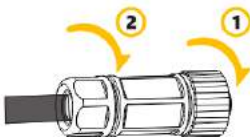

Step 4

Screw the connector into the socket and tighten firmly.



7. START UP AND OPERATION

7.1 Safety Check Before Start Up



Please check before switching on any voltage resources connected to the inverter and closing inverter's DC switch:

1. Grid Voltage: Check the grid voltage at point of connection at the inverter complies with permitted range of the inverter.
2. Mounting Bracket: Check if the mounting bracket is properly and securely installed.
3. Mounting of the inverter: Check if the inverter is properly mounted and attached to the mounting bracket.
4. DC Connectors: Check if the DC connectors are installed correctly on terminals.
5. AC Connectors and Wire Assembly: Check if wires are assembled correctly on the AC side and if the AC connector is properly and securely installed. Check if the AC connector is firmly plugged into AC terminal.
6. Cables: Check if all cables are reliably connected. Check if the connections are effective, while the insulations are undamaged.
7. Groundings: Check all groundings using multimeter and if all exposed metal parts of the inverter are properly grounded.
8. DC Voltage: Check if the largest open - circuit voltage of PV arrays complies with the permitted range.
9. DC Polarity: Check if the wires from DC voltage resource are connected to terminals with correct polarity.
10. Grounding Resistance: Check if the grounding resistance of PV strings $>1\text{M}\Omega$ using a multimeter.

After all installation and checks, close the AC circuit- breaker, then the DC switch. The inverter will start to operate when DC input voltage and grid conditions meet the requirements of inverter startup.

7.2 Inverter LED Indicators

When the inverter operates, LED symbols on display have the following meanings:

 <p>POWER</p>	<ul style="list-style-type: none"><input checked="" type="radio"/> ON Inverter Power ON and Feeding Power to Grid<input type="radio"/> Blink Inverter Power ON, Not Feeding Power to Grid<input type="radio"/> OFF Inverter Power OFF, DC Disconnected
 <p>FAULT</p>	<ul style="list-style-type: none"><input checked="" type="radio"/> ON Inverter is Faulty<input type="radio"/> OFF No Fault
 <p>COM</p>	<ul style="list-style-type: none"><input type="radio"/> Blink Communication Device Connected<input type="radio"/> OFF Communication Device Disconnected

8. DISCONNECTING FROM VOLTAGE RESOURCES

Before proceeding any operations on inverter, please disconnect the inverter from all voltage resources as described in this manual.

Following these steps in described sequence are mandatory.

1. Disconnect miniature circuit - breaker and prevent from unintentional reconnections.
2. Open the DC switch and prevent the switch from closing unintentionally.
3. Use clamps to ensure there is no electrical current in DC wires.
4. Disconnect all DC connections and resources. Unplug the DC connectors, and **DO NOT** pull the cables.



5. Use multimeter to ensure the voltage on DC terminals of inverter is 0.
6. Unscrew and remove the AC connector.

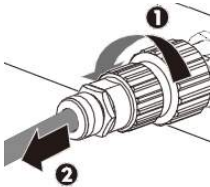



Danger to life due to high voltages.

Inverter capacitors need 10 minutes to be completely de -energized.

When an error occurs, **DO NOT** remove the cover of the inverter onsite. Improper operations and attempts may induce electric shock.

Fault Finding

Classifications of Fault Information

Fault Location	Fault Type	Error Message
 <p>DC Side Fault</p>	<p>Failures caused by PV side wiring</p>	<p>F5 - PV voltage too high F6 - Surface insulation resistance error F7 - GFCI exceeds the permissible range</p>
 <p>AC Side Fault</p>	<p>Various faults caused by abnormal power grid or AC side wiring</p>	<p>F0 - 10min average voltage over the protection range F9 - No grid F10 - The grid voltage is out of range F11 - The grid frequency exceeds the range F19 - The voltage of N-PE is too high</p>
 <p>Inverter Fault</p>	<p>Fault code caused by inverter itself</p>	<p>F1 - MCU fault F2 - Current sensor fault F3 - GFCI sensor fault F4 - Relay fault F12 - Dc component out of range F13 - EEPROM fault F14 - Master and slave DSP communication failure</p>
<p>Others</p>	<p>It may be caused by external installation environment, PV side and inverter itself. Further Diagnoses needed.</p>	<p>F8 - Temperature is out of range F15 - BUS voltage is too high F16 - BUS voltage is too low F17 - DRM S9 fault F18 - DRM S0 fault</p>

❖ Faults & Troubleshooting

Grid (AC) Side faults

Fault code	Fault	Solution
Fault 9	No Grid	<ol style="list-style-type: none"> 1. Check Ac (grid) Voltage In connector 2. Phase to Neutral voltages 200V – 250V 3. Phase to Phase Voltage 400V – 450V
Fault 10	The grid voltage is out of range	<ol style="list-style-type: none"> 1. Check Grid voltages 2. Phase to Neutral voltages 200V – 250V 3. Phase to Phase Voltage 400V – 450V
Fault 19	The voltage of N-PE is too high	<ol style="list-style-type: none"> 1. Check Ac side Neutral to Ground voltage less than 15V
Waiting	-	<ol style="list-style-type: none"> 1. Check Connection in AC connector 2. Grid voltages in inverter 3. check version & make Online system

(Panel) DC Side faults

Fault code	Fault	Solution
Fault 5	PV voltage too high	<ol style="list-style-type: none"> 1. Check DC side voltages 2. For single phase voltage under 500V 3. For Three phase voltage under 1000V
Fault 6	Surface insulation resistance error	<ol style="list-style-type: none"> 1. Check DC side Positive to Ground voltage & Negative to Ground voltage
Display Off	-	<ol style="list-style-type: none"> 1. Check string polarity 2. Check DC voltage For single phase 1kw -3.3kw start up voltage 80V – 500V For single phase 4kw -6.2kw start up voltage 100V – 550V For Three phase 3kw -60kw start up voltage 200V – 1000V For Three phase 60kw -110kw start up voltage 250V – 1100V 3. Loose connection in string / loose crimping

Log complaint on <https://bit.ly/3eRZba9>

Contact 8530111222 / 7888009282 / 7030955507 /01

11. SYSTEM MAINTENANCE

Content	Maintenance Measures	Cycle
System Cleaning	<ul style="list-style-type: none">• Check if the heat sink is covered and dusted	Annually OR Half a year
System Status	<ul style="list-style-type: none">• Inspect the enclosure for damage/deformation• Check if the parameters are normal during operation	Half a year
Commissioning	<ul style="list-style-type: none">• Check if the cables are loose• Check if the cable insulations are damaged, especially the parts in contact with metal surfaces	Half a year after first commissioning Annually OR Half a year
Grounding	<ul style="list-style-type: none">• Check if the cables are securely grounded	Half a year after first commissioning Annually OR Half a year

12. RESTART S

When reconnecting the inverter for electrical power supply, please follow the commissioning procedures and safety instructions as described in Section 6 when applicable (e.g. DC Wires need to be reassembled).

Please run safety checks as described in Section 7 before closing the DC Switch and starting up again.



Poonam petrol pump, KSolare Technology Park, Sr.No. 62,
Hissa No.03, Mangdewadi, Pune, Maharashtra 411046

Enquiry Email: Sales@ksolare.com

Service Email: service@ksolare.com

Contact: 853011222

Follow Us On

